

SAFARILAND®

INNOVATION NOT IMITATION.®

[DUTY GEAR CATALOG 2006]





INNOVATION NOT IMITATION.®

The SAFARILAND® Research and Development Team is a hands-on group of seasoned law enforcement veterans and competitive shooters. They use the products they design, day in and day out. They want the best, and you want the best. And Safariland stops at nothing to deliver just that.

Our R&D Team also has years of experience working with our professional customer base, listening, collaborating and innovating to create products that define the cutting edge. They also offer in-depth training to make sure our customers make the most of our products.

These are just a few of the reasons the SAFARILAND name has become synonymous with the ultimate in duty gear. Wear SAFARILAND and go with confidence.



[SCOTT CARNAHAN]

- Head of SAFARILAND® Research and Development for over 20 years
- Director of Marketing and Product Development for SAFARILAND Duty Gear
- Two-time USPSA National Class Champion
- Manager/shooter on TEAM SAFARILAND over 20 years
- Part of the SAFARILAND team for over 28 years



[BILL ROGERS]

- Former FBI Agent
- Master Class IPSC shooter and former State Trap Champion
- Owner/operator of the Rogers Shooting School since 1975
- Designer/engineer of holsters and related police and military gear for over 30 years
- Former owner of Rogers Holster Company, patented SAFARI-LAMINATE™ process



[TOM CAMPBELL]

- Over 30 years competitive shooting experience
- LE firearms instructor for 37 years
- 2001 USPSA Limited 10 National Champion
- 13 years on the USPSA Shooting Team/TEAM SAFARILAND member
- 22 years with Smith and Wesson, part of the SAFARILAND team for over 15 years



[MIKE LEHNER]

- LE firearms instructor for 27 years
- Former police officer for major city in California
- NRA distinguished (PPC) Shooter; IDPA Master Class
- 25 years competitive shooting experience
- Part of the SAFARILAND team for over 17 years

INNOVATION NOT IMITATION.®

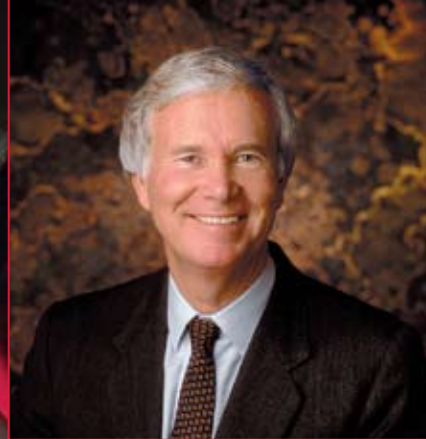

Throughout our over 45 years in business, our mission has been to research, design and bring to market the most technically advanced duty gear for the law enforcement and military professional, whose safety depends on it. This philosophy goes back to our very early beginnings in the 1960's as we built product on a single workbench.

A big part of our continued success with you, our customer is the Safariland Research & Development team and the shared experience, commitment and passion they have for the industry and products they develop. Evaluating new materials, testing new designs along with extensive testing in the field and on the range, the R&D team has the ability to bring a product to market that has truly been designed, developed and tested by seasoned professionals.

Neale Perkins
Founder



TABLE OF CONTENTS [DUTY GEAR CATALOG 2006]

[SAFARILAND® FINISHES]	4-5	[CONCEALMENT]	
[DUTY HOLSTERS]		Concealment Holsters.....	30-35
NEW ALS™ Holsters	6-7	NEW Concealment Holsters	36-37
Duty Holsters	8-11	Badge Holders	38
Duty/Tactical Holsters.....	12-17	Concealment Accessories.....	38-39
Super Duty™	18-19	[COMPETITION]	
[SAFARI-LAMINATE™]		Competition Holsters.....	40-41
Duty Belts	20-21	Competition Belts &	
Accessories.....	22-24	Accessories	42
Speedloaders & Accessories.....	25	Team SAFARILAND	43
[NYLOK® PRO]		[SHOULDER HOLSTERS]	44
Accessories.....	26-27	[SPECIALTY ITEMS]	
Holsters.....	27	Accessories.....	45
Belts	27-28	Dealer Support Items.....	46
[LEVITATION™]	29	[CONSUMER INFORMATION]	47

*Models not shown can be found on our web site at www.SAFARILAND.com.
*All holsters are available in right or left hand models.

[SAFARI-LAMINATE™]

Our original and most extensive holster and accessory line. While SAFARI-LAMINATE™ is a durable lamination process used to create many of our products, it is best known as the performance gear that law enforcement professionals recognize as the uniquely famous SAFARILAND® line.

[STX TACTICAL™]

A tactical finish famous for its incredible strength, abrasion resistance and protective qualities. Heat laminated and molded to the exact shape of weapons and accessories for better security. Will not absorb water or sweat, dries quickly, and is easily cleaned with mild soap and water or Armor All. A thin layer of Safari-Suede™ in the liner protects the finish of guns and absorbs excess oils or lubricants.

[NYLOK® PRO]

NYLOK® PRO accessories incorporate the SAFARI-LAMINATE™ process in a special molding process that bonds 1050 denier DuPont nylon to a non collapsible shell. The result is professional looking gear that is lightweight, durable, waterproof and resists tears and fading. We recommend STX Duty holsters for NYLOK® PRO rigs.

[SUPER DUTY™]

Super Duty® gear looks like leather—but without the cost or the maintenance. Can be cleaned with a damp rag—no polishing needed. It is extremely durable, abrasion and fade resistant and retains its function and shape in hot or cold climates.

SAFARI-LAMINATE™**STX TACTICAL™****NYLOK® PRO****SUPER DUTY™****[STANDARD FINISHES]**

SAFARILAND® Duty Gear finishes are designed to protect your investment by offering outstanding durability and appearance year-in and year-out.

[BASKET WEAVE]**[HI-GLOSS]****[PLAIN BLACK]****[STX TACTICAL™]****[NYLOK® PRO]****[CUSTOM FINISHES]**

The following custom finishes are also available based on minimum order quantities. Call customer service for details.

[STX™ HI-GLOSS BLACK]**[STX™ PLAIN BLACK]****[CARBON FIBER LOOK]****[NYLON LOOK]****[CORDOVAN]**

IMPORTANT NOTE: Individual products may have limited finish or color choices.

AUTOMATIC LOCKING SYSTEM (ALS™) The ALS™ system is the next evolution in retention holsters and builds upon the successful SELF LOCKING SYSTEM (SLS). With many patents to its credit, the key to this system is an internal locking device that secures the weapon in all directions simply upon re-holstering, providing Level II Plus Retention™ which can also be elevated to Level III Plus Retention™ with the addition of the Sentry.

Additionally, holsters with this all-new ergonomic design are completely operable with the thumb making training easy, and the straight up draw makes them very instinctive to use, yet difficult for an assailant's attempted takeaway.

And finally, once the retention devices are released, the weapon can be drawn straight out of the holster with no twisting or other motion required.

The ALS series holsters cover a wide array of market needs from retention duty holsters, to models in our popular tactical offerings, to a belt slide and paddle holster for the concealment markets, both with and without the SLS.

- 1 The ALS is a unique new design that locks into the ejection port and is operated by the thumb once the SLS is released.
- 2 The SLS rotating hood has been tested and proven for many years on the 6280 and 6004 series of holsters. Simply push down and rotate forward as you obtain your shooting grip. To close, pull back on the hood and the SLS self locks. No snaps or straps to manipulate.
- 3 The Hood Guard helps protect the SLS from impact and premature release especially in an attempted take away. Included with all duty and tactical versions.
- 4 Constructed of SAFARI-LAMINATE™, a thermal molded holster to help protect the handgun and vital components for years of use.
- 5 Injection molded jacket slot UNIVERSAL BELT LOOP (UBL) is very strong and comfortable. Available in standard belt ride and 1.5" drop version for 2" or 2.25" belt slots.



6360 [ALS™ LEVEL II PLUS] WITH RIDE UBL

- Level II Plus Retention™
- Level III Plus Retention™ with optional Sentry installed
- ALS™ Automatic Locking System secures weapon once holstered
- Hood Guard is standard on 6360 holsters
- Slim, compact design allows weapon to ride close to body
- Simple straight up draw once all releases are de-activated
- Includes Hood Guard, optional Sentry available
- Mid Ride belt loop
- Available in Plain Black, Basket Weave, Hi-Gloss finish or STX TACTICAL™



[DUTY HOLSTERS]



6365 [ALS™ LEVEL II PLUS] WITH DROP UBL

- Level II Plus Retention™
- Level III Plus Retention™ with optional Sentry installed
- ALS™ Automatic Locking System secures weapon once holstered
- Hood Guard is standard on 6365 holsters
- Slim, compact design allows weapon to ride close to body
- Simple straight up draw once all releases are de-activated
- Includes Hood Guard, optional Sentry available
- 1.5" Belt Drop version
- Available in Plain Black, Basket Weave, Hi-Gloss finish or STX TACTICAL™

6361 [ALS™ BELT SLIDE HOLSTER WITH SLS]



6368 [ALS™ PADDLE HOLSTER WITH SLS]



6351 [ALS™ BELT SLIDE HOLSTER]



6358 [ALS™ PADDLE HOLSTER]



[CONCEALMENT HOLSTERS]

6304 [ALS™ TACTICAL HOLSTER]



6305 [ALS™ TACTICAL HOLSTER WITH QUICK RELEASE LEG HARNESS]



[TACTICAL HOLSTERS]

RAPTOR
SERIES

RAPTOR™ Holsters feature these SLS accessories:

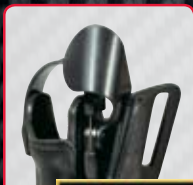

SLS
HOOD GUARD

6000

SLS Hood Guard

- Features a uniquely designed accessory protection for the SLS holster system
- Will adapt to any SLS Holster
- Colors: Black, Brown Flat Dark Earth

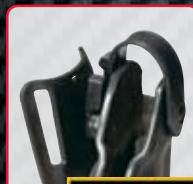

SLS
SENTRY

6001

SLS Sentry

- Features a uniquely designed accessory protection for the SLS holster system
- Will adapt to any SLS holster
- Converts 6270, 6275 to Level III Retention™
- Converts 6070, 6075, 6295, 62955 to Level IV Retention™
- Colors: Black

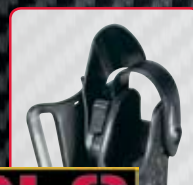

SLS
SENTRY
HOOD GUARD

6002

SLS Sentry/Hood Guard

- Features the Sentry installed into the hood guard
- Will adapt to any SLS holster
- Colors: Black



6070 **RAPTOR**
SERIES
[RAPTOR™ LEVEL III]
STANDARD RIDE UBL

- Available in Level III or Level IV Retention™ (with optional Sentry)
- Middle finger release tab
- Level II Retention™ upon reholstering
- Available in Plain Black, Basket Weave, Hi-Gloss or STX TACTICAL™ finishes
- Offered in 2" or 2.25" belt slots only



6075 **RAPTOR**
SERIES
[RAPTOR™ LEVEL III]
DROP UBL

- Holster rides 1.5" (38mm) lower than the 6070
- Highly recommended for female officers
- Middle finger release tab
- Level II Retention™ upon reholstering
- Available in Plain Black, Basket Weave, Hi-Gloss or STX TACTICAL™ finishes
- Offered in 2" or 2.25" belt slots only



6270 **RAPTOR**
SERIES
[RAPTOR™ LEVEL II PLUS]
STANDARD RIDE UBL

- Level II Retention™ holster
- Level III Retention™ with optional Sentry installed
- Mid-ride position allows excellent weapon protection and quick, easy draw
- SLS (Self Locking System)
- Molded ejection port insert—push down on handgun to lock
- Rock slightly back to draw
- Available in Plain Black, Basket Weave, Hi-Gloss or STX TACTICAL™ finishes
- Offered in 2" or 2.25" belt slots only

6275 NOT SHOWN **RAPTOR**
SERIES
[RAPTOR™ LEVEL II PLUS]
DROP UBL

- SLS (Self Locking System)
- Molded ejection port insert—push down on handgun to lock
- Same as 6270, yet holster rides 1.5" (38mm) lower
- Highly recommended for female officers
- Available in Plain Black, Basket Weave, Hi-Gloss or STX TACTICAL™ finishes
- Offered in 2" or 2.25" belt slots only

070
[SSIII]

- Level III Retention™ holster
- Mid-ride belt position and slightly-forward grip cant allows for comfort carry and quick, easy draw
- Top thumb break and middle finger release tab, internal ejection port lock
- For pistols or revolvers
- Available in Plain Black, Basket Weave, Hi-Gloss, or Nylon Look finishes
- Model 0705 (Not shown) rides 1.5" lower than the 070
- Offered for 2.25" belt slot only



2005
[TOP GUN] WITH UBL & 1.50
(38 MM) BELT DROP

- Level I Retention™ holster
- 1.50" (38mm) belt drop
- Features a top draw, mid-ride, straight drop cant and a thumb break with a one-way directional snap
- Adjustable holster tensioning device easily allows the controlling of friction with the turn of a screw
- For pistols or revolvers
- Available in Plain Black, Basket Weave, Hi-Gloss or Nylon Look finishes
- Model 200 (Not shown) is standard ride version
- Model 2 (Not shown) is hi-ride version
- Offered in 2" or 2.25" belt slots only



295
[MID-RIDE] WITH UBL

- Level II Retention™ holster
- Features front wrap-around thumb break and an internal trigger guard lock for secure weapon retention
- Mid-ride belt position and slightly forward grip cant allow for comfort carry and quick, easy draw
- Not available for revolvers
- Available for double-action only pistols; not recommended for single-action or conventional double-action pistols
- Available in Plain Black, Basket Weave, Hi-Gloss, or Nylon Look finishes
- Model 2955 (Not shown) rides 1.5" lower than the 295
- Offered in 2" or 2.25" belt slots only





- 6280**
[WITH UBL] AVAILABLE FOR LIGHT MOUNTED GUN
- Level II Retention™ holster
 - SLS (Self Locking System)
 - Mid-Ride position allows for excellent weapon protection and quick easy draw
 - Top draw and straight drop cant
 - For pistols or revolvers
 - Level III Retention™ with optional Sentry installed
 - Available Plain Black, Basket Weave, Hi-Gloss, Nylon Look or STX TACTICAL™ finishes
 - Offered in 2" or 2.25" belt slots only

- 6285**
[WITH UBL] NOT SHOWN
- Level II Retention™ holster
 - SLS (Self-Locking System)
 - Top draw and straight drop cant
 - Model 6285 rides 1.5" lower than the 6280
 - Offered in 2" or 2.25" belt slots only



- 6280**
[TASER® DUTY HOLSTER] LEVEL II STANDARD RIDE UBL
- Now available to carry advanced Taser® M26 or X26
 - Offered in 2" or 2.25" belt slots only



- 6281 UBS**
[WITH UBL] TASER ACCESSORY BELT MOUNTING SYSTEM
- Level II Retention™ holster
 - SLS (Self Locking System)
 - Snap on belt attachment for Taser holsters
 - Adjustable cant for optional cross-draw wear
 - Available in Plain Black, Hi-Gloss or Nylon Look finishes
 - Snap on belt attachment for Taser® holsters
 - Offered in 2" or 2.25" belt slots only

- 6295**
[WITH UBL]
- Level III Retention™ holster
 - Level IV Retention™ with optional Sentry installed
 - SLS (Self Locking System)
 - Mid-ride position allows excellent weapon protection and quick, easy draw
 - Internal trigger guard lock for secure weapon retention
 - Model 62955 (Not shown) rides 1.5" lower than the 6295
 - Available Plain Black, Basket Weave, Hi-Gloss or STX TACTICAL™ finishes
 - Offered in 2" or 2.25" belt slots only



- 284**
[TOP DRAW THUMB BREAK]
- Level I Retention™ holster
 - Mid-ride belt position
 - Conventional thumb break hammer strap
 - For pistols only
 - Available in STX TACTICAL™ finish
 - Insert included for 2" belts with STX TACTICAL™
 - Offered for 2.25" belt slots only

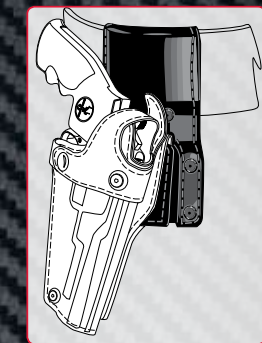

- 325**
[DUTY BELT DROP, HOLSTER ADAPTER]
- Holster adapter lowers mid-ride position by 2.5"
 - Available for models 0707 and 284; not available for UBL belt loops

UBL
[UNIVERSAL BELT LOOP]

We know that sometimes wearing a holster can be painful. That's why we developed the Universal Belt Loop (UBL). Once you wear it, you'll become a believer. The UBL is stronger and half the weight of the old-style belt loop. Even better, it won't pinch or add pressure to the hip bone.

- Added comfort, especially for the female officer
- Stronger and half the weight of the old style belt loop
- Will not pinch or add pressure to hip bone (support ridge removed from the belt shank)
- Locks onto the duty belt with belt slot design, no belt tension screws needed, will not damage top of belt
- Easier to mount onto the belt
- Converts holster to the 3-hole pattern, can convert holster to other style belt loops, (i.e. Drop version for duty, concealment, paddle, belt-slide, or tactical)



6070UBL
2" or 2.25"

P2201
Converts 2.25" UBL to a 2" belt slot

6075UBL
2" or 2.25"

560BL
Up to 1.75"

561BL
Up to 1.75"

6281BL
1.5", 1.75" or 2.25"



- 6001**
SLS Sentry
- Features a uniquely designed accessory protection for the SLS holster system
 - Will adapt to any SLS holster
 - Converts 6270, 6275 to Level III Retention™
 - Converts 6070, 6075, 6295, 62955 to Level IV Retention™
 - Colors: Black



- 6280**
[w/UBS] UNIVERSAL BELT SYSTEM
- To carry advanced Taser® M26 crossdraw (holster mounted with UBS)



6004
[SLS TACTICAL HOLSTER]

- Features the SLS (Self Locking System) rotating hood system
- Hood Guard is standard on 6004 holsters
- SLS allows for a smoother, single-motion draw and greater protection against attempted weapon takeaways
- Thermal-molded SAFARI-LAMINATE™ construction protects handgun and sights
- Standard double leg strap and leg shroud with mounting holes for optional accessories
- Available in Woodland Camo, Day Desert Camo, Brown Flat Dark Earth, Foliage Green or STX TACTICAL™ Black finishes



6004
[SLS TACTICAL HOLSTER]

- To carry advanced Taser® M26 or X26

**FULL PRODUCT INFORMATION
FEATURED ON PAGE 15.**



6004
[WOODLAND CAMO FINISH]
LIGHT MOUNTED GUN



6004
[BROWN FLAT DARK EARTH FINISH]
LIGHT MOUNTED GUN



6004
[DAY DESERT CAMO FINISH]
LIGHT MOUNTED GUN



6004
[FOLIAGE GREEN FINISH]
LIGHT MOUNTED GUN



PHOTO COURTESY OF U.S. ARMY.

6005
[SLS TACTICAL HOLSTER]
LIGHT MOUNTED GUN & QUICK RELEASE LEG HARNESS

- All the features of the Model 6004
- Fits several models with lights and lasers attached to handgun
- Hood Guard is standard on 6005 holsters
- Quick release leg harness
- Features the SLS (Self Locking System) rotating hood system
- SLS allows for a smoother, single-motion draw and greater protection against attempted weapon takeaways
- Thermal-molded SAFARI-LAMINATE™ construction protects handgun and sights
- Standard double leg strap and leg shroud with mounting holes for optional accessories
- Available in Day Desert Camo, Brown Flat Dark Earth, STX TACTICAL™ Black, Woodland Camo and Foliage Green colors

6304
[ALS™ TACTICAL HOLSTER]

- ALS™ Automatic Locking System secures weapon once holstered
- Includes SLS hood assembly and Hood Guard
- Hood Guard is standard on 6304 holsters
- Mounted to the same leg shroud assembly as the popular 6004 series
- Simple straight up draw once all releases are de-activated
- Optional Sentry available
- Thermal-molded SAFARI-LAMINATE™ construction protects handgun and sights
- Standard double leg strap and leg shroud with mounting holes for optional accessories
- Adjustable vertical leg strap
- Available in Black, STX TACTICAL™, Woodland Camo, Day Desert Camo, Foliage Green, Flat Dark Earth Brown

6305
[ALS™ TACTICAL HOLSTER]
WITH QUICK RELEASE LEG HARNESS

- ALS™ Automatic Locking System secures weapon once holstered
- Includes SLS hood assembly and Hood Guard
- Hood Guard is standard on 6305 holsters
- Mounted to the same leg shroud assembly as the popular 6005 series
- Simple straight up draw once all releases are de-activated
- Optional Sentry available
- Thermal-molded SAFARI-LAMINATE™ construction protects handgun and sights
- Standard double leg strap and leg shroud with mounting holes for optional accessories
- Adjustable vertical leg strap with quick release detachable leg harness
- Available in Black STX TACTICAL™, Woodland Camo, Day Desert Camo, Foliage Green, Flat Dark Earth Brown

6005
[SLS TACTICAL HOLSTER]
QUICK RELEASE LEG HARNESS

- All the features of the Model 6004
- Features the SLS (Self Locking System) rotating hood system
- Hood Guard is standard on 6005 holsters
- SLS allows for a smoother, single-motion draw and greater protection against attempted weapon takeaways
- Thermal-molded SAFARI-LAMINATE™ construction protects handgun and sights
- Standard double leg strap and leg shroud with mounting holes for optional accessories
- Available for Taser® M26 or X26
- Available in Woodland Camo, Day Desert Camo, Brown Flat Dark Earth, Foliage Green or Black finishes

6074
[SPECIAL OPS HOLSTER]

- Middle finger release tab
- Mounted to the same leg shroud as the 6004
- Hood Guard is standard on 6074 holsters
- Same holster body as 6070
- Available in Black, Woodland Camo, Day Desert Camo, Foliage Green and Brown colors

6274
[SLS TACTICAL HOLSTER]

- Rock slightly back to draw
- Features the SLS (Self Locking System) rotating hood system
- Hood Guard is standard on 6274 holsters
- SLS allows for a smoother single-motion draw and greater protection against attempted weapon takeaways
- Thermal-molded SAFARI-LAMINATE™ construction protects weapon
- Standard double leg strap and leg shroud with mounting holes for optional accessories
- Available in Black, Woodland Camo, Day Desert Camo, Foliage Green and Brown colors
- Same holster body as 6270



6005-7
DETACHABLE 3X™
LOCKING BUCKLE

- For quick release of holster/shroud – perfect for agencies sharing Tasers®
- Available in Brown or Black



PHOTO COURTESY OF U.S. ARMY.



6004-6
[HARNES AND SHROUD]

- Features harness and shroud only to mount accessories
- Ambidextrous
- Available in Woodland Camo, Day Desert Camo, Brown Flat Dark Earth, Foliage Green or Black finishes



[DUTY TACTICAL ACCESSORIES]

SAFARILAND® OFFERS A WIDE SELECTION OF DUTY TACTICAL ACCESSORIES THAT ARE EASY TO MOUNT AND EXCHANGE ON THE LEG SHROUD.

SHOWN HERE IS THE MODEL 6004 SLS TACTICAL HOLSTER WITH LIGHT, WITH A DISTRACTION DEVICE HOLDER AND DOUBLE MAG POUCH.

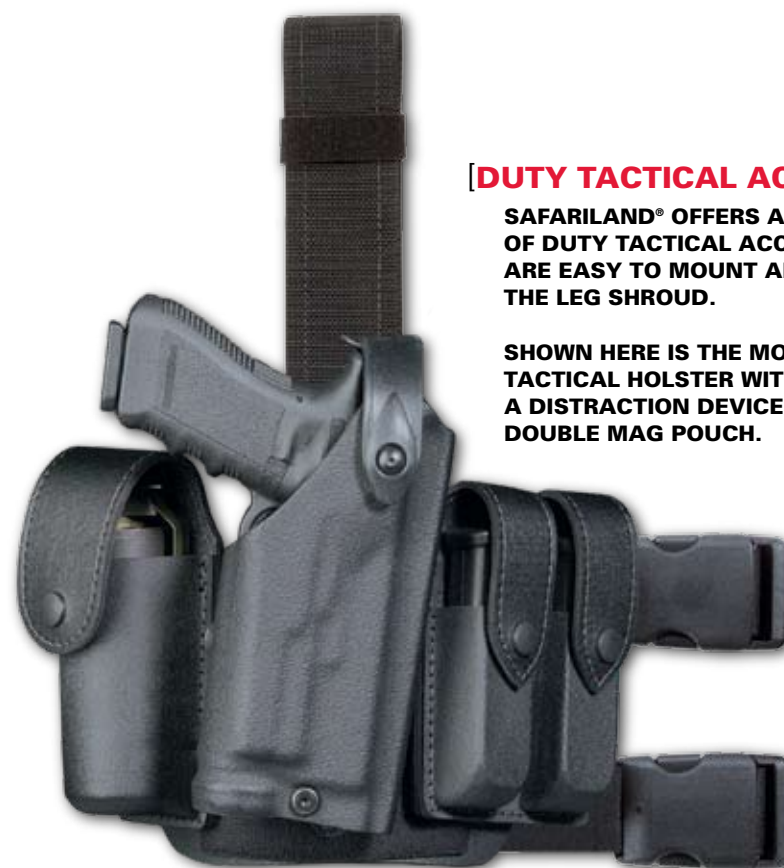

DUTY TACTICAL ACCESSORIES

- 6004-5-13
- 6004-5-51
- 6004-5-52
- 6004-5-54
- 6004-5-55

- MOLLE Adapter Plate – Black
- MOLLE Adapter Plate – Woodland Camo
- MOLLE Adapter Plate – Day Desert Camo
- MOLLE Adapter Plate – Olive Tactical Green
- MOLLE Adapter Plate – Brown Flat Dark Earth

- 6004-6-123
- 6005-6-123
- 6004-6-553
- 6005-5-553
- 6004-4-2
- 6004-4-55

- To convert holster to a model 6004, Black
- To convert holster to a model 6005, Black
- To convert holster to a model 6004, Brown Flat Earth (BFDE)
- To convert holster to a model 6005, Brown Flat Dark Earth (BFDE)
- Leg Shroud only, Black
- Leg Shroud only, Brown Flat Dark Earth (BFDE)

Note: Molded shroud only, including wrench-Does not include any elastic or webbing

- 6005-7-2
- 6005-7-55

- Harness and buckle, Black
- Harness and buckle, Brown Flat Dark Earth (BFDE) Including Brown Buckle

- 76-53-23PBL
- 76-76-23PBL
- 76-83-23PBL
- 76-383-23PBL
- 76-210-23PBL

- Single Mag Pouch, Handguns - 1911
- Single Mag Pouch, Handguns - 5906, 226, 96F
- Single Mag Pouch, Handguns - Glock, 17, 19, 22, 23
- Single Mag Pouch, Handguns - Glock, 20, 21
- Single Mag Pouch, Handguns - S&W 1006, 4506-1

- 77-53-23PBL
- 77-83-23PBL
- 77-383-23PBL
- 77-210-23PBL
- 77-76-23PBL
- 77-94-23PBL

- Double Mag Pouch, Handguns - 1911
- Double Mag Pouch, Handguns - Glock, 17, 19, 22, 23
- Double Mag Pouch, Handguns - Glock, 20, 21
- Double Mag Pouch, Handguns - S&W 1006, 4506-1
- Double Mag Pouch, Handguns - 5906, 226, 96F
- Double Mag Pouch, Handguns - H&K, MK23

- 771-216-231
- 771-216-232
- 771-215-231
- 771-215-232
- 772-216-231
- 772-216-232
- 772-215-231
- 772-215-232

- Single Mag Pouch - H&K MP5 Right-hand shooter
- Single Mag Pouch - H&K MP5 Left-hand shooter
- Single Mag Pouch - Colt AR15 Right-hand shooter
- Single Mag Pouch - Colt AR15 Left-hand shooter
- Single Mag Pouch with flap - H&K MP5 Right-hand shooter
- Single Mag Pouch with flap - H&K MP5 Left-hand shooter
- Single Mag Pouch with flap - Colt AR15 Right-hand shooter
- Single Mag Pouch with flap - Colt AR15 Left-hand shooter

- 40-2-23PBL
- 40-1-23PBL
- 35-F26-23
- 4672-2-23PBL

- Distraction Device Holder to fit DTFL OmniBlast 100
- Distraction Device Holder Complete for DTFL #25
- Expandable Baton Pouch - up to 4.5" (114mm) long
- Folding Knife and Leatherman Pouch - up to 4.5" (114mm) long

- 38-2-23PBL
- 38-3-23PBL
- 38-4-23PBL
- 38-23PBL

- OC Spray Pouch - 1.4 x 4" (35mm x 102mm)
- OC Spray Pouch - 1.4 x 5" (35mm x 127mm)
- OC Spray Pouch - 1.5 x 4" (38mm x 102mm)
- OC Spray Pouch - 1.5 x 6" (38mm x 152mm)

6005-6
[LEG STRAP WITH DETACHABLE 3X™ LOCKING BUCKLE]

- Features harness and shroud only to mount accessories
- Ambidextrous
- Available in Woodland Camo, Day Desert Camo, Brown Flat Dark Earth, Foliage Green or Black finishes



6004-5
[MOLLE ADAPTER PLATE]

- Adapter unit designed to convert most SLS duty and tactical holsters to a MOLLE vest system
- Ambidextrous
- Available in Woodland Camo, Day Desert Camo, Brown Flat Dark Earth, Foliage Green or Black finishes



6004-4-2
[LEG SHROUD ONLY]
• Available in Black or Brown (6004-4-55)

PHOTO COURTESY OF U.S. ARMY.

Super Duty™

MAINTENANCE FREE SHARPNESS

The new SUPER DUTY™ line of accessories uses a revolutionary injection molded process which allows for flexibility while ensuring maximum comfort and maintaining a professional appearance.

SUPER DUTY™ accessories are truly maintenance free. Durable SUPER DUTY™ accessories are highly abrasion and fade resistant and can stand up to the hottest or coldest climates.

Our one piece molding will not absorb perspiration, water or blood born pathogens. SUPER DUTY™ is so flexible removing or replacing accessories is much easier. Best of all, SUPER DUTY™ always looks professional at an economical price.



ALL SUPER DUTY™ PRODUCTS:

- Fit up to 2.25" (58mm) belts
- Are available with Chrome, Brass, Black and Hidden snaps
- Offers high abrasion resistance
- Includes water drain hole
- Available in Plain Black and Basket Weave finishes

38M
[OC SPRAY HOLDER, TOP FLAP]

- Top flap for added security

190M
[SINGLE HANDCUFF POUCH]

- Chained cuffs only

77M
[DOUBLE MAGAZINE HOLDER]

- Vertical/horizontal belt slots for regular/low-profile position
- Tension screw allows you to adjust magazine retention
- Span between pouches, plus low cut, allows quick, easy drawing

76M NOT SHOWN
[SINGLE MAGAZINE HOLDER]

306M
[MINI-FLASHLIGHT CARRIER]

- Half-sheath style fully protects selected mini-flashlights

35M
[BATON HOLDER]

- Designed for expandable baton
- Extended baton can be reholstered
- Fits 16" (40.64cm), 21" (53.34cm) or 26" (66.04cm) length batons

90M
[SINGLE HANDCUFF POUCH]

- Chained cuffs only

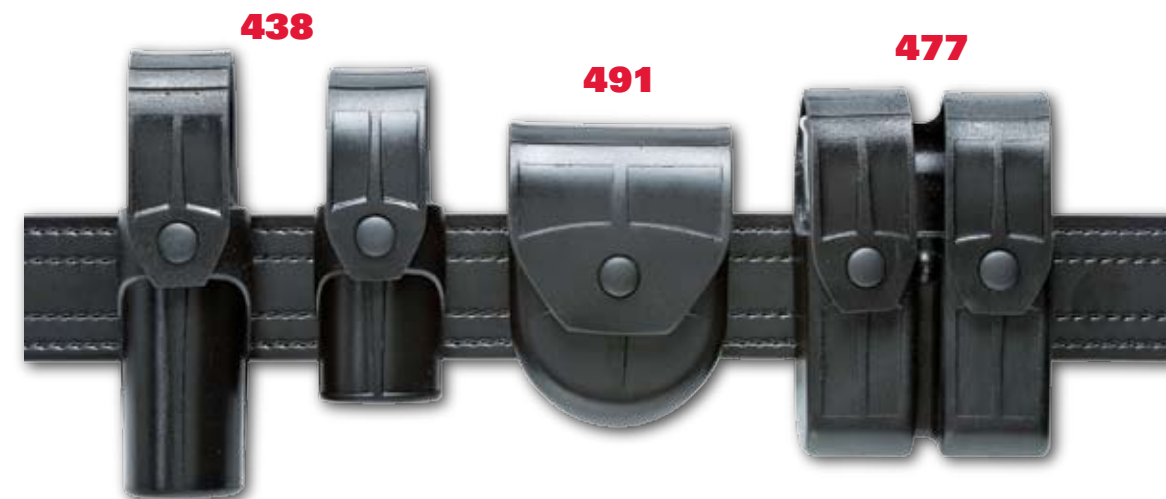

ALL SUPER DUTY™ TACTICAL PRODUCTS:

- Fit up to 2.25" (58mm) belts
- Are available with Black snaps only
- Includes water drain hole
- Available in Plain Black finish
- Molded out of a special non-abrasive material
- Flexible flaps for ease of draw

438
[OC SPRAY POUCH]

- Two sizes available

491
[SINGLE CUFF POUCH]

- Molded out of a special non-abrasive material
- Chained cuffs only

477
[DOUBLE MAGAZINE POUCH]

- Radius corners for extreme comfort
- Can be worn vertical or horizontal
- Tension screw allows you to adjust magazine retention





183 NOT SHOWN
[HOOK-AND-LOOP
SELF STICK SET]

- Designed to work with Models 87V, 94, 99, 992, 941 & 942
- Ideal for fastening accessories to these belts



94
[BUCKLELESS WITH HOOK-AND-LOOP SYSTEM] 2.25" (58MM)

- Features a hidden brass hook and a hook-and-loop closure on both ends
- Belt is lined with a band of hook-and-loop and attaches to the lining on the Model 99, or 992, completing the Buckleless system

94P NOT SHOWN
[BUCKLELESS WITHOUT HOOK-AND-LOOP SYSTEM]
2.25" (58MM)



51
[GARRISON WITH SQUARE BUCKLE] 1.75" (45MM)

- Standard unlined 1.75" (45mm) Garrison belt
- Includes removable square chrome or brass buckle



875
[STITCHED EDGE WITH BUCKLE BELT] 2.25" (58MM)

- Standard duty belt with a plain border stitch
- Double-tongued buckle and center belt stud fastens belt firmly around waist
- Choice of chrome or brass buckle



146
[BORDER PATROL WITH BUCKLE] 2.25" (58MM)

- Standard buckle fastens the belt firmly around the waist
- The 1.25" (32mm) and 2.25" (58mm) keepers hold the interior and exterior belt tips in place
- Choice of chrome or brass buckle



87
[SUEDE LINED WITH BUCKLE] 2.25" (58MM)

- Standard duty belt with a suede lining
- Double-tongued buckle and center belt stud fastens belt firmly around waist
- Free-sliding keeper holds the belt tip in place

87V NOT SHOWN
[SUEDE LINED HOOK-AND-LOOP SYSTEM] 2.25" (58MM)

- Standard duty belt with a suede lining
- Includes an interior band of hook-and-loop



99
[BUCKLELESS REVERSIBLE BELT] 1.5" (38MM)

- Hook-and-loop can be worn on the outside, creating a Buckleless system
- Order 999 for belt without loop lining



872
[CONTOURED BELT] 2.25" (58MM)

- Designed especially for policewomen yet also comfortable for men with same features as the 87
- 2.25" (58mm) duty belt is contoured for proper alignment and greater comfort
- Greater all day comfort by distributing weight evenly. No sharp edges to dig into hips



941
[CONTOURED BUCKLELESS BELT WITH
HOOK-AND-LOOP SYSTEM] 2" (50MM) OR 2.25" (58MM)

- Designed specifically for policewomen yet also comfortable for men
- Greater all day comfort by distributing weight evenly. No sharp edges to dig into hips
- Features a hidden brass hook and a hook-and-loop closure on both ends
- Tip of belt points to the left side of the officer
- Belt is lined with a band of full-length hook lining and attaches to the lining on the Model 99 or 992, completing the Buckleless system



942
[CONTOURED BUCKLELESS BELT WITH
HOOK-AND-LOOP SYSTEM] 2" (50MM) OR 2.25" (58MM)

- Designed specifically for policewomen yet also comfortable for men
- Greater all day comfort by distributing weight evenly. No sharp edges to dig into hips
- Tip of belt points to the right side of the officer
- Lined with hook-and-loop to mate with 99 underbelt
- Features a hidden brass hook closure
- Order 942P for belt without hook lining



992
[REVERSIBLE SAFARI-LAMINATE™ BELT] 1.50" (38MM)

- Lined with loop material
- Designed to be worn under duty belts with hook as the foundation of the SAFARILAND® belt systems
- The 992 is the contour version of the 99



* THESE ITEMS ARE AVAILABLE IN STX TACTICAL™ FINISH.



76*
[SINGLE MAGAZINE HOLDER]

- Fits a 2.25" (58mm) duty belt

77, 77HS*
[DOUBLE MAGAZINE HOLDER]

- Vertical/horizontal belt slots for regular/low-profile position
- Tension screw allows you to adjust magazine retention
- Span between pouches, plus low cut, allows quick, easy drawing
- Fits a 2.25" (58mm) duty belt

65*
[BELT KEEPER]

- Standard 0.75" (19mm) belt keeper
- Design matches all 2.25" (58mm) duty belts
- Also available for 2" (50mm) belts

654
[BELT KEEPER]

- Slot fits up to 1.75" (45mm) belts

62HS
[BELT KEEPER]

- Standard 1.00" (25mm) belt keeper
- Hidden Snap closure

63
[BELT KEEPER]

- Slotted, two-snap belt keeper
- Slot fits up to 1.75" (45mm) belts

655
[BELT KEEPER]

- Rugged, heavy duty, two-snap belt keeper
- Extra wide at 1.25" (32mm)

170*
168, HK-10
169S*

170*
[SILENT KEY RING]

- SAFARI-LAMINATE™ key ring
- Hook-and-loop adjustable pouch

168
[KEY RING]

- Heavy-duty metal spring hook
- Protective flap

HK-10
[HANDCUFF KEY]

- Stainless steel

169S*
[KEY RING]

- Heavy-duty metal spring hook
- Allows for easy key removal

730
[FLASHLIGHT RING]

- Heavy-duty
- Features a shatter-resistant nylon ring
- 1 snap
- Also fits C-cell flashlights

67S
[BATON RING WITH SNAP]

- Also fits C-cell flashlights

67 NOT SHOWN
[BATON RING]

- Without snap
- Also fits C-cell flashlights

692S*
[BATON RING]

- For side handle batons

306*
[MINI-FLASHLIGHT CARRIER]

- Half-sheath style fully protects selected mini flashlights

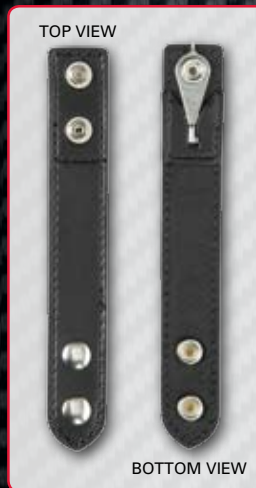

HK-11*
[HIDE-A-KEYPER™]

- Hidden handcuff key



090
[SINGLE HANDCUFF POUCH]

- Open top formed

90
[SINGLE HANDCUFF POUCH]

- Specify chain or hinged cuffs

290
[DOUBLE HANDCUFF POUCH]

- Fits chain or hinged cuffs

190, 190H
[SINGLE HANDCUFF POUCH]

- Specify chain or hinged cuffs

690*
[HANDCUFF STRAP]

- Secures one pair of cuffs to your duty rig

768*
[PAGER CARRIER]

- Metal clip attachment to fit 2" to 2.25" duty belts

307*
[LIGHT/TASER® HOLDERS]

- Fits 2"-2.25" (50mm-58mm) duty belt
- Pouch to hold lights for mounting to gun
- TASER® cartridge holder

33*
[SURGICAL GLOVE POUCH]

- Hook-and-loop closure
- Holds one or three pair of surgical gloves, please specify

767
[CASSETTE RECORDER POUCH]

- For the Olympus Voice & Music DM-1 recorder

764 NOT SHOWN
[CASSETTE RECORDER CASE]

- Fits recorders up to 2.5" W x 1.5" H x 3.5" L (64 x 38 x 89mm)
- Features a protective pouch and an adjustable bungee cord tie-down with a snap closure
- Fits duty belts up to 2.25" (58mm) wide



* THESE ITEMS ARE AVAILABLE IN STX TACTICAL™ FINISH.



381
[MACE® SPRAY HOLDER POUCH]

- Fits MK-9 Magnum, Training Unit only
- Metal clip for easy removal on and off belt



38
[OC SPRAY HOLDER, TOP FLAP]

- Top flap for added security
- Includes Chrome, Black, Brass or Hidden Snap closure



760*
[RADIO CARRIER]

- Features an adjustable hook-and-loop strap

761*
[RADIO CARRIER]

- Formed protective pouch
- Adjustable bungee cord tie-down with a snap closure
- Fits most standard portable police radios

762*
[RADIO CARRIER]

- Features a detachable swivel belt loop for easy retrieval
- Protective pouch and adjustable bungee cord tie-down with a snap closure

763*
[RADIO CARRIER]

- Universal fit
- Features an adjustable band to fit almost any standard portable police radio
- Bottom lip retains the radio from falling through



35*
[BATON HOLDER]

- Designed for expandable baton
- Extended baton can be reholstered
- Fits 16" (406mm), 21" (533mm) or 26" (660mm) length batons

135*
[BATON HOLDER]

- Designed for expandable baton
- Fits 16" (406mm), 21" (533mm), or 26" (660mm) length batons
- 26" length also fits Streamlight Stinger®
- Available in two sizes for 1.5" and 2"-2.25" belts

765*
[MACE® SPRAY HOLDER, UNIVERSAL]

- Fits both MK-9 Magnum and Training Unit

38*
[OC SPRAY HOLDER, TOP FLAP]

- Top flap for added security
- Includes Chrome, Black, Brass or Hidden Snap closure

37*
[OC SPRAY HOLDER, OPEN TOP]

- Open top for quick access



370, 370-HS
[SPLIT-SIX SPEEDLOADER HOLDER]

- Double speedloader holder
- Featuring ultra-low profile and quick, easy, single-action draw, provides the fastest "top-flap" speedloader holder available
- Design carries three cartridges on either side of the belt
- Allows you to grip both sides of the loader while unsnapping the top flap
- Designed for 2.25" (58mm) belts

371
[SPLIT-SIX SPEEDLOADER HOLDER]

- Single speedloader
- Featuring ultra-low profile and quick, easy, single-action draw, provides the fastest "top-flap" speedloader available
- Design carries three cartridges on either side of the belt
- Allows you to grip both sides of the loader while unsnapping the top flap
- Designed for 1.75" (45mm) belts

340
[SPEEDLOADER HOLDER]

- Standard double speedloader
- Fits 2.25" (58mm) duty belts
- Choice of chrome or brass snap

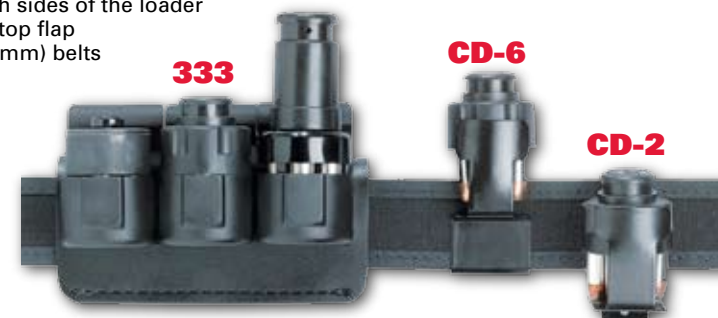

333
[COMPETITION SPEEDLOADER HOLDER]

- Features external clips and molded loader cups for ultra-quick access
- Fits 1.75" (45mm) or 2.25" (58mm) belts
- Available in Black

CD-6
[SPEEDLOADER HOLDER]

- Strong, epoxy-coated steel clips
- Lined with a vinyl pad insert to ensure loader stability
- Split-Six CD-6 is designed for 1.75" (45mm) belts
- Available in Epoxy finish

CD-2
[SPEEDLOADER HOLDER]

- Strong, epoxy-coated steel clips
- Lined with a vinyl pad insert to ensure loader stability
- CD-2 clips firmly onto any belt up to 2" (50mm) wide
- Available in Epoxy finish

J-KTR, J-LP
[LOADING BLOCKS]

- Convenient trays hold wadcutter, semi-wad cutter, or round nosed .38 or .357 ammunition
- Popular for all speedloaders
- Available in Black

COMP-I
[SPEEDLOADER]

- Injection-molded
- Popular for concealment
- Features a small knob providing maximum concealment for small-frame revolvers
- Large-frame versions offer maximum grip clearance
- Available in Black only

COMP-II
[SPEEDLOADER]

- Injection-molded
- Popular for duty use
- Features a small knob providing maximum concealment for small-frame revolvers
- Medium-size knob for ease of locking closed
- Large-frame versions offer maximum grip clearance
- Available in Black only

COMP-III
[SPEEDLOADER]

- Injection-molded
- Popular for competition
- Spring-driven to offer the fastest weapon reloading device
- Available in Black only



ML-1, ML-2
[MAGAZINE LOADERS]

- Pocket-sized loaders allow fast and easy reloading of magazine clips
- ML-1 fits all double-row 9mm and single-row .45 magazines, except for Glock and H&K
- ML-2 Submachine Gun magazine loader fits Beretta, Colt, H&K, Uzi 9mm Carbine, and Submachine Gun magazines



080-12
[SHOTGUN SHELL HOLDER/BEAN BAG]

- Molded shotgun shell holder holds (2) 12-gauge shells
- Clips on for easy-on, easy-off use
- Belt clip features an extended bottom hook for security
- Fits belts up to 2.25" (58mm)
- Available in Black only

NYLOK® PRO

IT'S TIME TO GO PRO...

NYLOK® PRO answers law enforcement's need for lightweight, professional-looking equipment that can stand up to the toughest abuse. Made of durable ballistic nylon, it's lightweight, rugged and resists scuffs, tears, and fading.

The new NYLOK® PRO product line combines the best of our original, patented NYLOK® Survival Gear line, with major improvements. We have added molded accessories of SAFARI-LAMINATE™ with non-glare black matte snap closures that fit belts up to 2.25" for a sharper, cleaner look. In addition, NYLOK® PRO has been upgraded from a 950 denier to a 1050 denier. Law enforcement professionals know...it's time to go PRO.

The NYLOK® PRO line of accessories was designed to be used with SAFARILAND'S STX TACTICAL™ duty holsters.



4110 [DOUBLE MAGAZINE HOLDER]

- Featuring a two-way belt loop for either vertical or horizontal use
- Adjust the tension screw for extra magazine retention for a more custom fit
- SAFARI-LAMINATE™ molded construction

4100 [SINGLE MAGAZINE HOLDER]

- Five sizes available
- Fits 2.25" (58mm) belt loop
- SAFARI-LAMINATE™ molded construction

4238 [FLASHLIGHT POUCH]

- Flap-style mini flashlight pouch carries most mini flashlights

4208 [BATON POUCH]

- Fits 2.25" (58mm) belt loop
- SAFARI-LAMINATE™ molded construction
- Available for most 21" (53.34cm) or 26" (66cm) foam-handle expandable batons



4291 [RADIO POUCH, STANDARD]

- Fits 2.25" (58mm) belt loop
- SAFARI-LAMINATE™ molded construction
- Available 2" x 2.8" x 3.75" (51mm x 73mm x 95mm)
- Available 1.6" x 2.25" x 3.5" (41mm x 60mm x 89mm)

4298 [RADIO POUCH, SWIVEL]

- Fits 2.25" (58mm) belt loop
- SAFARI-LAMINATE™ molded construction
- Available 2" x 2.8" x 3.75" (51mm x 73mm x 95mm)
- Available 1.6" x 2.25" x 3.5" (41mm x 60mm x 89mm)

4258 [HANDCUFF POUCH, SINGLE TOP FLAP]

- Constructed of molded SAFARI-LAMINATE™
- Fits chained cuffs
- Fits belts up to 2.25"

4278 [OC POUCH]

- Fits many small canisters up to 4.5" (11cm) high

4072 [HEAVY DUTY HI-RIDE HOLSTER]

- Made for active field duty performance
- Tough, lightweight, and washable
- Rugged bolt-on belt loop and bolted-in trigger guard stop
- Great for bicycle or dirt bike patrols, marine units, wildlife officers, search & rescue, etc.
- Fits belts up to 2.25"

[PLEASE VISIT SAFARILAND.COM FOR MORE INFORMATION ON THE FOLLOWING HOLSTERS.]

4052 NOT SHOWN [BATWING HOLSTER]

4061 NOT SHOWN [INSIDE-THE PANTS HOLSTER]

4062 NOT SHOWN [STUFFER INSIDE THE PANTS HOLSTER]

4071 NOT SHOWN [PADDLE THUMB BREAK HOLSTER]

4073 NOT SHOWN [SNAP STRAP FIELD HOLSTER]



NYLOK® ACCESSORIES NOT SHOWN

MAGAZINE HOLDERS

- 4102 Single, Universal fit
- 4116 Double, Universal fit
- 4135 Speedloader Holder

BELT KEEPERS

- 4200 Set of 4, 2 snaps
- 4203 Belt Keeper with Hidden Key

BATON/KEY RINGS

- 4201 Expandable Baton Holder
- 4210 Baton Ring w/Flashlight Carrier (C-Cell)
- 4220 Baton Ring—PR-24®
- 4235 Key Ring—Flap
- 4236 Key Ring—Silent
- 4237 Key Ring—Standard

FOLDING KNIFE CASE

- 4672 Expandable Baton Holder

HANDCUFF POUCHES

- 4250 Handcuff Pouch—Single
- 4260 Handcuff Pouch—Double

OC SPRAY HOLDERS

- 4271 Top Flap

FLASHLIGHT CARRIERS

- 4227 Flashlight Carrier—Ring
- 4230 Flashlight Carrier
- 4238 Flashlight Pouch

RADIO/PAGER CASES

- 4275 Pager Case
- 4290 Cassette Recorder Case
- 4292 Radio Case—Padded
- 4293 Radio Case—Universal
- 4294 Radio Case—Swivel
- 4297 Epaulet Strap for Radio Microphone



4092 [ANKLE HOLSTER]

- Retains your concealed handgun from rotating around and down your ankle
- Uniquely designed lightweight system
- Supported from the ground up by attaching a small support strip to your shoe
- Right or left hand
- Available in Black only

4092 NOT SHOWN [SOCK]

- Accessory Sock for 4092 Ankle Holster



B4305 [3X™ LOCKING BUCKLE]

- Features full-length hook lining
- Includes two Flex-Cuff™ channels
- 2" (50mm) belt width
- 4307 2.25" (58mm) belt width
- Available in Black only



4300 [BALLISTIC NYLON LAMINATED DUTY BELT WITH 3X™ LOCKING BUCKLE]

- Features full-length hook lining
- 2" (50mm) belt width
- 2" (50mm) version of Model 4305
- Available in Black only



4302 & 4307 [BALLISTIC NYLON LAMINATED DUTY BELT WITH 3X™ LOCKING BUCKLE]

- Features full-length hook lining
- Includes two Flex-Cuff™ channels
- 2" (50mm) belt width
- 4307 2.25" (58mm) belt width
- Available in Black only

NYLOK® PRO



4301
[POLYMER REINFORCED NYLON WEBBING DUTY BELT WITH 3X™ LOCKING BUCKLE]

- Features full-length hook lining
- 2" (50mm) belt width
- Available in Black, Brown, Olive Green, and Tan



4304
[BALLISTIC NYLON LAMINATED BUCKLELESS LOCKING DUTY BELT]

- Features full-length hook lining
- 2" (50mm) belt width
- Available in Black only
- **4309** in 2.25" (58mm)



4310
[BALLISTIC NYLON LAMINATED DUTY BELT]

- 2" (50mm) belt width
- Available in Black only
- Shown with optional buckle cover

4310BC
[BUCKLE COVER]

- Features locking belt cover
- Fits belt models 4300, 4301, 4302, 4304, 4310
- Available for 2" (50mm) and 2.25" (58mm) buckles
- Available in Black only



4305
[BALLISTIC NYLON LAMINATED DUTY BELT WITH 3X™ LOCKING BUCKLE]

- A third center lock for added security
- Features full-length hook lining
- 2.25" (58mm) belt width
- Available in Black only
- **4306** similar design to the 4305 both ends are skived, allowing a lower profile around the buckle

031
[D-RING BELT]

- Reinforced instructor style belt
- Available in 1.5" (38mm)
- Lined with loop material

4325
[BALLISTIC NYLON/LEATHER LAMINATED REVERSIBLE POLICE PANT BELT]

- Features full-length loop lining
- 1.5" (38mm) belt width
- Available in Black only

4571
[GAS MASK CARRIER]

- Designed to carry the MSA Millennium mask
- Worn on the leg, supported by a harness and an elastic strap with a quick release buckle and thermo molded buckle cover
- Two pockets to hold 4 decon wipes on each end that secure with a hook-and-loop closure, size: 4" x 10" x 7" (11cm x 25cm x 18cm)



4600
[DELUXE PADDED GLOVE/MICROSHIELD CASE]

- Size: 3.5" x 4" (9cm x 10cm)
- Available in Black with matte snap or hook-and-loop flap

4612
[STANDARD GLOVE/MICROSHIELD CASE]

- Size: 3.5" x 4" (9cm x 10cm)
- Available in Black with matte snap

4620
[DELUXE GLOVE/MICROSHIELD CASE]

- Features two compartments
- Size: 3" x 3" x 1.5" (8cm x 8cm x 4cm)
- Available in Black with matte snap or hook-and-loop flap

ABOVE THREE PRODUCTS:

- Carry two pairs of latex gloves or one pair of gloves and one microshield
- 2.25" (58mm) belt loop

LEVITATION™

LEVITATION™ TUBE BELT:

For the ultimate in comfort, try the LEVITATION™ Tube Belt System. Top and bottom tubes on the belt eliminate pressure on your hips and back. Accessories lock-on to the belt from the outside, thus eliminating the bumps and edges between the belt and your waist. The LEVITATION™ can make wearing your duty rig much more pleasant.

- A smarter approach to Duty Belts
- Designed with soft and flexible tubing to increase comfort
- Less than half the weight of conventional duty belts
- Top and bottom tubes eliminate pressure on hips and back
- "Lock-on" system attaches to holster and accessories utilizing a locking wedge that completely secures the holster and accessories to the belt eliminating the bumps and edges between the belt and your waist
- Must be worn with the 99 or 992 hook-and-loop under belts, keepers are not needed
- Available in NYLOK® PRO finish only
- Contact SAFARILAND® for information, video or CD-Rom



54336



54327



54620



54600



54294



54116 54201 54292 54230 54271 54250 56075

LEVITATION™ ACCESSORIES SOME ITEMS NOT SHOWN

- | | | | |
|----------------|---|-----------------|--|
| 5200 | Duty Holster Level I Retention™ | 54346 | Ballistic Nylon Laminated Duty Belt 1.5" (38mm) Buckle |
| 52005 | Duty Holster Level I Retention™ | 54327 | Belt |
| 5295 | Duty Holster Level II Retention™ | 54600 | Latex Glove Pouch |
| 52955* | Duty Holster Level II Retention™ | 56070 | Duty Holster Level III RAPTORTM |
| 54116 | Double Magazine Pouch, Universal | 56070UBL | Belt Loop Only Standard Ride |
| 54118 | Double Magazine Pouch, Horizontal | 56075* | Duty Holster Level III RAPTORTM |
| 54201 | Expandable Baton Holder | 56075UBL | Belt Only 1.5" (38mm) Drop |
| 54230 | Flashlight Carrier | 56270 | Duty Holster Level II RAPTORTM |
| 54250 | Handcuff Pouch Single Top Flap | 56275* | Duty Holster Level II RAPTORTM |
| 54260 | NYLOK® PRO Handcuff Pouch-Double | 56280 | Duty Holster Level II Retention™ |
| 54271 | OC Pouch | 56285* | Duty Holster Level II Retention™ |
| 54292 | Radio Case | 56295 | Duty Holster Level III Retention™ |
| 54292-7 | NYLOK® PRO Stun Gun Pouch | 562955* | Duty Holster Level III Retention™ |
| 54294 | Radio Case, Swivel | 5767 | Cassette Recorder Pouch |
| 54336 | Ballistic Nylon Laminated Duty Belt 1.5" (38mm) w/Hook-And-Loop Lining + Buckle | | |

*1.50" (38mm) belt drop

CONCEALMENT HOLSTERS: UNDERCOVER OR PLAINCLOTHES....

Whether you need an "invisible" holster for deep undercover, a comfortable concealable holster for long hours of plainclothes duty, or simply a reliable holster for off-duty use but concealed, you can rely on SAFARILAND® products. Our holsters offer comfort in a variety of popular designs, models, and finishes—all with a low-profile print and reliable performance.



0701 [CONCEALMENT HOLSTER]

- Features a dual retention system consisting of the trigger guard strap and an internal lock
- Mid-ride belt position and slight tilt forward for comfortable wear and smooth draw
- Tough outer layer adds further protection
- Available in STX TACTICAL™ finish



0702 [SELF-SECURING PADDLE CONCEALMENT HOLSTER]

- Features a unique spring-loaded, self-securing frame jack, automatically locks on the ejection port when you re-holster
- No straps and no snaps
- Mid-ride belt position and slight tilt forward for comfortable wear and smooth draw
- Comes standard with a comfortable paddle
- Fits belts up to 1.5" (38mm)
- For pistols only
- Available in STX TACTICAL™ finish



0706 [SELF-SECURING BELT SLIDE HOLSTER]

- Features a unique spring-loaded, self-securing frame jack, automatically locks on the ejection port when you re-holster
- No straps and no snaps
- Comes standard with a belt-slide
- Can be worn in a cross-draw position
- Fits 1.5" (38mm), 1.75" (45mm), and 2.25" (58mm) belt loops. Please specify
- Available in STX TACTICAL™ finish

329 [CONTOUR CONCEALMENT HOLSTER]

- Originally designed for women, but very comfortable for men as well
- Low-cut front, no need to raise handgun very high to clear holster
- Utilizes thumb break design
- Sturdy, flexible belt loop for added comfort
- Holster stays close to body when closed, yet moves away when unsnapped for ease of draw
- Fits belts up to 1.25" (32mm) wide
- Adjustable tension device
- Constructed of sturdy SAFARI-LAMINATE™



528 [OPEN TOP PANCAKE HOLSTER]

- Specially designed for a Federal Law Enforcement Agency
- Holster covers muzzle of gun protecting your weapon and clothing
- Low profile body hugging
- Features a molded detent that grips the trigger guard
- Fits 1.75" (45mm) belt loop
- Available in Plain Black finish



747 [PANCAKE CONCEALMENT HOLSTER]

- Specially designed for a Federal Law Enforcement Agency
- Extremely low profile, compact and body hugging
- Thumb break/hammer strap and top draw design
- Fits belts up to 1.75" (45mm)
- Available in Plain Black finish



329
The 329 holster stays close to body when closed, yet moves away when unsnapped for ease of draw.



25
[INSIDE-THE-POCKET HOLSTER]

- Extra-thin, extra-soft holster for extra-deep concealment
- Available in Plain Black finish

518
[PADDLE HOLSTER]

- Features medium to hi-ride carry, wrap-around design, and adjustable tensioning device to provide excellent weapon retention
- Suede-lined, custom-formed thumb break paddle holster is lightweight and comfortable
- Available in Plain Black, Basket Weave or Carbon Fiber Look finish



27
[INSIDE-THE-PANTS HOLSTER]

- J-shaped belt hook can be worn with any belt
- Available in Plain Black finish



5181
[OPEN TOP PADDLE HOLSTER]

- Thermal-molded, self-lock paddle allows for easy placement and removal of the holster
- Tension device allows for customizing holster draw by adjusting resistance
- Available in Plain Black or STX TACTICAL™ finish



L820



L830

FULL PRODUCT INFORMATION FEATURED ON PAGE 39.

328
[PANCAKE-STYLE BELT HOLSTER]

- Pancake-style holster
- Can be adjusted to two different cant positions
- Thumb break/hammer strap and top draw design
- Fits belts up to 1.75" (45mm)



5182
[PADDLE HOLSTER]

- Compact, light weight, and thermally molded with SAFARI-LAMINATE™
- Low-cut sides for ease of draw and added comfort
- Flexible and comfortable paddle with hook to secure holster to pants or belt
- Holster comes with spacer kit to adjust the angle and space between the holster and body
- Available in STX TACTICAL™ finish only





5186 [BELT SLIDE HOLSTER]

- Fits 1.5" (38mm), 1.75" (45mm), 2" (50mm), and 2.25" (58mm) belt loops. Please specify
- Holster comes with spacer kit to adjust the angle and space between the holster and body
- Low-cut sides for ease of draw and added comfort
- Compact, lightweight, and thermally molded with SAFARI-LAMINATE™
- Available in STX TACTICAL™ finish only



573



079

FULL PRODUCT
INFORMATION
FEATURED ON
PAGE 38 & 39.

527 [BELT SLIDE HOLSTER]

- Low-profile, body hugging design
- Features a molded detent that grips the trigger guard
- Fits 1.75" (45mm) belt loop
- Available in Plain Black finish



560 [CUSTOM FIT HOLSTER]

- Adjusts to a wide variety of popular handguns, fits more than 90 pistol designs (9mm and larger)
- Ergonomically designed paddle will contour and conform to the wearer's body
- Available in Plain Black and Carbon Fiber Look finish

561 [CUSTOM FIT HOLSTER]

- Belt slide version of 560
- Belt loop adjusts for cant
- Belt loop accommodates belts from 1" (25mm) to 1.75" (45mm)
- Can be worn in a cross-draw position
- Available in Plain Black finish

561BL NOT SHOWN [OPTIONAL BELT ATTACHMENT]

- Optional belt attachment for the Model 560 paddle holster
- Adjusts to various widths of dress belts
- Available in Plain Black finish



6281 [CONCEALMENT HOLSTER]

- Concealment version of the SLS holster
- Features a unique rotating hood design and semi-hi-ride position and slightly forward cant
- Rides close to the body, aiding in concealment and weapon retention
- Fits 1.5" (38mm), 1.75" (45mm), and 2.25" (58mm) belt loops. Please specify
- Adjustable tension device
- Comes with Spacer Kit to adjust angle and stand off from the body
- Available in Plain Black or STX TACTICAL™ finish



6518 [SLS PADDLE HOLSTER]

- Concealment version of the SLS holster
- Suede-lined, custom-formed, paddle holster
- Features medium-to-hi-ride carry, wraparound design
- Offers a user-adjustable tensioning device providing excellent weapon retention
- Comes with Spacer Kit to adjust angle and stand-off from the body
- Available in Plain Black or STX TACTICAL™ finish



1060 FRONT



1060 MAG POUCH



1090 GUN QUICK™

FULL PRODUCT
INFORMATION
FEATURED ON
PAGE 44.



6078
[RAPTOR™ PADDLE HOLSTER]

- Features middle finger release tab
- Includes SLS System
- Molded ejection port insert – push down on handgun to lock
- Same draw action as the 6070
- Formed sturdy paddle design for comfort and easy on and off



6278
[RAPTOR™ PADDLE HOLSTER]

- DOES NOT utilize middle finger release tab
- Includes SLS System
- Molded ejection port insert – push down on handgun to lock
- Same draw action as the 6270
- Formed sturdy paddle design for comfort and easy on and off



6361 NEW!
[ALS™ BELT SLIDE HOLSTER WITH SLS]

- ALS™ Automatic Locking System secures weapon once holstered
- Includes SLS hood assembly and Hood Guard
- Slim, compact design allows weapon to ride close to body
- Simple straight up draw once all releases are de-activated
- Optional Sentry available
- Available for 1.5", 1.75", 2", or 2.25" belt slots
- Available in Plain Black or STX TACTICAL™

6368 NEW!
[ALS™ PADDLE HOLSTER WITH SLS]

- ALS™ Automatic Locking System secures weapon once holstered
- Includes SLS hood assembly and Hood Guard
- Slim, compact design allows weapon to ride close to body
- Simple straight up draw once all releases are de-activated
- Optional Sentry available
- Formed, sturdy paddle design for comfort and easy on and off
- Available in Plain Black or STX TACTICAL™



6351 NEW!
[ALS™ BELT SLIDE HOLSTER]

- ALS™ Automatic Locking System secures weapon once holstered
- Slim and low profile design for improved concealment
- Low ride design for ease of draw
- Simple straight up draw once all releases are de-activated
- Available for 1.5", 1.75", 2", or 2.25" belt slots
- Available in Plain Black or STX TACTICAL™

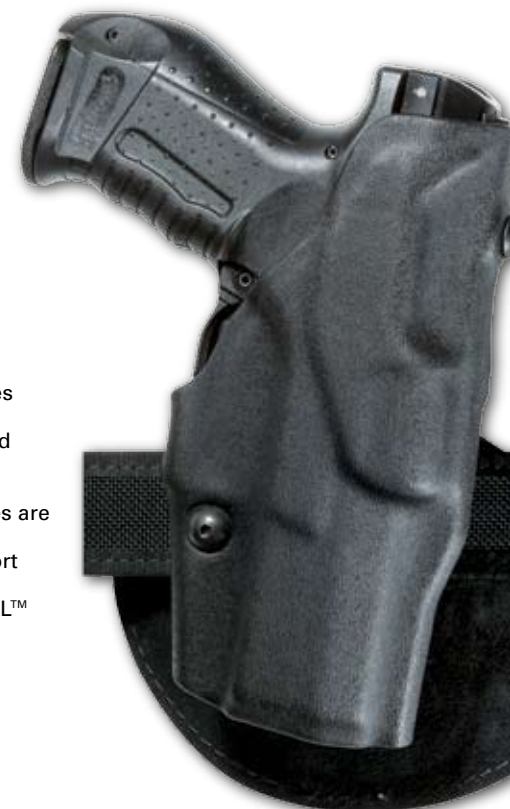

6358 NEW!
[ALS™ PADDLE HOLSTER]

- ALS™ Automatic Locking System secures weapon once holstered
- Slim and low profile design for improved concealment
- Low ride design for ease of draw
- Simple straight up draw once all releases are de-activated
- Formed, sturdy paddle design for comfort and easy on and off
- Available in Plain Black or STX TACTICAL™



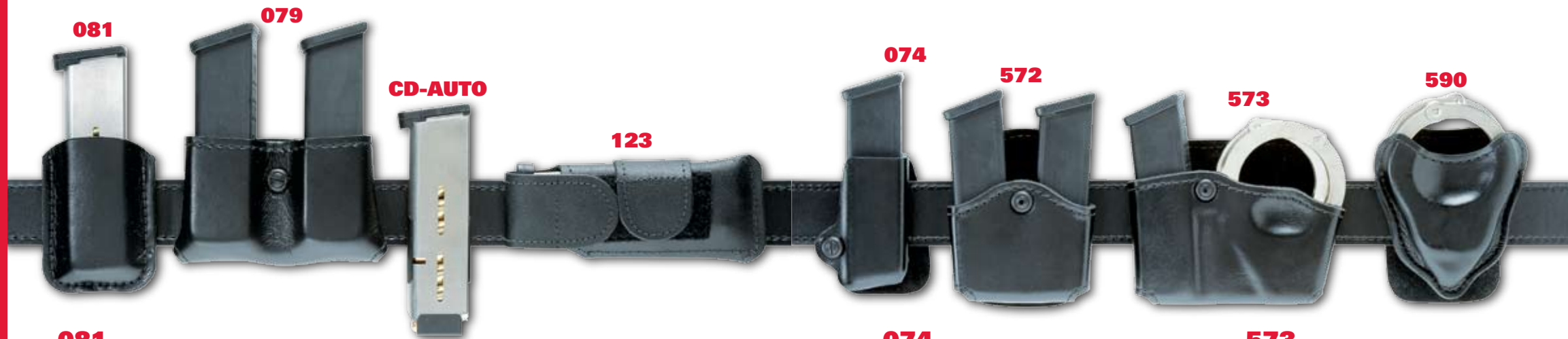

081
[MAGAZINE HOLDER]

- Features a low-cut design
- Back side folds over to form snap-type belt loop
- For use on belts up to 1.75" (45mm)
- Available in Plain Black finish

079
[DOUBLE MAGAZINE HOLDER]

- Low-cut design for easy magazine grasp
- For use on belts up to 1.75" (45mm) wide
- Adjustable tension device
- Available in Plain Black, Basket Weave, STX TACTICAL™ or Carbon Fiber look finish

CD-AUTO
[AUTO MAGAZINE HOLDER]

- Metal clip-on
- Carries single magazine in a butt-up, mid-ride position
- Ideal for plainclothes or off-duty use
- Available in Plain Black finish

123
[MAGAZINE HOLDER]

- Single magazine holder—carries magazines in a horizontal position
- Hook-and-loop belt attachment wraps around belt
- Hook-and-loop flap keeps the magazine in the pouch
- Available in Plain Black finish

074
[SINGLE MAGAZINE HOLDER]

- Paddle-style single magazine holder
- Features built-in locking mechanism that keeps the holder in place at all times
- Fits belts up to 1.50" (38mm) wide
- Adjustable tension device
- Available in Plain Black, STX TACTICAL™ or Carbon Fiber look finish

572
[DOUBLE MAGAZINE HOLDER]

- Low-cut design allows for quick access
- Unique paddle design features a self-locking belt hook
- Adjustable tension device
- Available in Plain Black finish

573
[MAGAZINE HOLDER & HANDCUFF POUCH]

- Unique paddle design features a self-locking belt hook
- Adjustable tension device
- Available in Plain Black finish

590
[HANDCUFF POUCH]

- Thermal-formed laminate handcuff holder holds the handcuffs firmly and quietly in place
- Unique paddle design features a self-locking belt hook
- Available in Plain Black finish



7350-03
[BADGE HOLDER]

- Shaped for shield-style badges
- Metal clip
- 2.5" x 3.5" (64mm x 89mm)

7350-01 NOT SHOWN
[BADGE HOLDER]

- Circular clip-holder for star-shaped badges
- Metal clip
- Diameter: 3" (76mm)

7352
[BADGE HOLDER]

- Neck chain style for shield-style badges
- 2.5" x 3.5" (64mm x 89mm)

7352-04 NOT SHOWN
[BADGE HOLDER]

- Shaped for federal-style badges
- Metal clip
- 2.25" x 3.25" (58mm x 83mm)



L820
[PLAINCLOTHES BELT] 1.25" (32MM)

- Made of SAFARI-LAMINATE™ with a vegetable tanned leather support to accommodate holsters for larger handguns
- Withstands the weight of heavy guns
- Features a solid brass or chrome buckle
- Available in Plain Black or Carbon Fiber Look finish with chrome buckle



L830
[PLAINCLOTHES BELT] 1.5" (38MM)

- Made of SAFARI-LAMINATE™ with a vegetable tanned leather support to accommodate holsters for larger handguns
- Withstands the weight of heavy guns
- Features a solid brass or chrome buckle
- Available in Plain Black, Basket Weave or Carbon Fiber Look finish with chrome buckle

SEE PAGE 20 FOR MORE BELTS.



012 COMPETITION HOLSTER

- Body machined out of aluminum to stabilize the handgun, but offers little resistance for a secure and fast draw
- Fits 1911's, SVI's and CZ clones from 5" to 7.5" (13cm to 19cm) in length, with or without scopes
- Patented injection molded adjustable trigger guard lock
- Front nosepiece designed to retain handgun
- Will help prevent gun from being knocked out of a holster while seated
- Able to adjust holster up and down, twist in or out, angle forward or back to custom fit your draw
- Available in Black nylon only
- Order **5012** for 54307 Levitation™ Belt

SAFARILAND® Competition Holsters and LEVITATION™ Belt...the perfect combination for serious competitors.

The SAFARILAND® Competition LEVITATION™ Rig is so comfortable and so fast, it will work magic on your draw. The featherweight LEVITATION™ Belt molds to the contours of your body and features hollow tubes on top and bottom that roll away from pressure. The result is the most comfortable belt on the market. And our Competition Holsters are machined out of aluminum for stability, while offering little resistance to your drawing action. Together they form a combination that meets the needs of today's shooters.

- 1 Hollow tube design rolls away from pressure to keep you comfortable
- 2 Fully adjustable magazine pouches for a custom fit
- 3 Adjustable tension device for a custom fit
- 4 Aluminum base provides stable gun position and drawing base
- 5 Adjustable muzzle guard

5012



012



010 ["TACTICAL OPTION" HOLSTER]

- The world's fastest tactical competition holster features our patented injection molded, adjustable trigger guard locking device which prevents the pistol from rocking forward
- Fingertip tension knob instantly adjusts the holster's "grip" on the weapon
- Hook-lined belt tab works with our loop lined under belt and competition belts to form a stable mounting system that allows you to quickly adjust cant and angle
- Fits scoped and non-scoped pistols 5" to 7" (13cm to 18cm)
- Available in Carbon Fiber Look and STX TACTICAL™ finish.



007 COMPETITION HOLSTER

- Features a hook-and-loop lined adjustable belt loop
- Front is low-cut to promote the smoothest, quickest draw
- Hook-and-loop lined belt tab provides a firm and adjustable carry when used with SAFARILAND® hook-and-loop lined belts
- Holster cant or angle can quickly be changed with no loss of weapon stability
- Adjustable tension device
- Locks on ejection port
- For pistols only
- Available in Black with Basket Weave or STX TACTICAL™ finish



002 ["CUP CHALLENGE" COMPETITION HOLSTER]

- Features dual-tension screws on the holster body; one in back of cylinder and other in back of barrel allowing a balanced retention of the handgun
- Hook-and-loop lined belt tab provides a firm and adjustable carry when used with SAFARILAND® 028 or 4350 buckleless hook-and-loop lined competition belts
- Accommodates both scoped and non-scoped revolvers as well as most revolvers with standard, heavy, and slab side barrels
- Built-in removable muzzle strap protects front sights
- Available in new Carbon Fiber Look, Black with Basket Weave or STX TACTICAL™ or Carbon Fiber Look finishes





771/5771
[MAGAZINE HOLDER]

- Features two magazine tensioning screws on back side of the holster to adjust tension on both the middle and end of the magazine
- Sits against plastic rollers that reduce drag during draw
- Open-front design keeps your index finger from touching the holder during reload, assuring fast reload
- 771 available in Basket Weave, STX TACTICAL™ or Carbon Fiber Look finishes
- Order 5771 for LEVITATION™ System—available in STX TACTICAL™ finish only

773/5773
[ADJUSTABLE MAGAZINE POUCH]

- Utilizes the 90-degree adjustable belt loop
- 2 sets of tension screws threaded through rollers for greater adjustment and lightning-fast reloads
- Closed low-cut front to help secure magazine and prevent it from being knocked out the front of the pouch
- Built-up channel for clearance of the bullet during the draw
- 773 available in Basket Weave, STX TACTICAL™ or Carbon Fiber Look finishes
- Order 5773 for LEVITATION™ System—available in STX TACTICAL™ finish only

177
[MAGAZINE HOLDER]

- Features an adjustable tension device
- Fully adjustable belt loop
- Available in Black with Basket Weave finish

030 NOT SHOWN
[WEB BELT-LOOP LINED]

- Underbelt for LEVITATION™ System with hook-and-loop
- Must use loop lined belt for LEVITATION™ Systems

077BL NOT SHOWN
[REPLACEMENT BELT LOOP ACCESSORY]

- Available for 1.5" (38mm), 1.75" (47mm), and 2.25" (58mm) belts
- Fits 771, 773, and 177
- Available in Black

083 NOT SHOWN
[HOOK-AND-LOOP SELF STICK KIT]

- Ideal for fastening accessories to the belts
- Designed to work with Models 4350, 028, and 029

008-1 NOT SHOWN
[TRIGGER GUARD TENSION BLOCK]

- Replacement for the discontinued Model 008 Competition Holster for both right and left handed versions

009-1 NOT SHOWN
[TRIGGER GUARD TENSION BLOCK]

- Replacement for Models 009, 010, 012 and 5012 Competition Holsters for both right and left handed versions



028
[BUCKLELESS BELT] 1.5" (38MM)

- Reinforced to hold heavy competition handguns and ammunition
- Loop lined to hook to 029 underbelt
- Available in Black with Basket Weave and new Carbon Fiber Look finish



0282
[CONTOUR COMPETITION GUNFIGHTER BELT]

- Designed specifically for women, but works well for male or female
- Provides greater comfort by distributing the weight of the holster and accessories evenly around the body
- Lined with hook-and-loop to mate with the 029 under belt
- Available in Nylon Look and new Carbon Fiber Look finish



029
[BUCKLELESS BELT] 1.5" (38MM)

- Underbelt for Models 028, 0282 and 4350
- Belt is worn in regular pant belt loops with the hook exposed to mate with outer belt loop
- Available in Black with Web finish



4350
[BUCKLELESS BELT] 1.5" (38MM)

- Designed to be used with the SAFARILAND® NYLOK® PRO series holsters and accessories with the STX TACTICAL™ finish
- Reinforced to hold heavy competition handguns and ammunition
- Loop lined to hook to 029 underbelt
- Available in Black with Tactical Nylon finish



54327
[LEVITATION™ TUBE BELT]

- Soft and flexible tubing increases comfort—less than half the weight of conventional duty belts
- Must be worn with the 030, 99, or 992 loop under belt
- Keepers are not needed
- Available in NYLOK® PRO finish only



[TEAM SAFARILAND]

Team SAFARILAND® was started in 1985 and is an integral part of our product-development process. Team members have combined competition and LE-trainer experience and regularly field-test materials and products for SAFARILAND®. Their involvement helps keep us at the very forefront of cutting edge design.



[JOHN PRIDE]

- Won 3-regional NRA PPC matches
- Won 10 out of 20 state police matches
- #1 NRA Police President's 100
- #1 California Governor's 20
- Set new Match-4 National PPC Record
- 4 time NRA Bianchi Cup Champion



[ROB LEATHAM]

- 2005 IPSC World Shoot XIV Champion (5th time)
- 2005 USPSA Nationals Champion (16th time)
- 2005 NRA Bianchi Cup Champion (5th time)
- 2005 SINGLE STACK CLASSIC CHAMPION (11th Consecutive Year)
- 6-TIME STEEL CHALLENGE CHAMPION
- 6 TIME IDPA CDP NATIONAL CHAMPION
- 3-TIME AMERICAN HANGUNNER® WORLD SHOOTOFF® CHAMPION
- 1985 TRIPLE CROWN WINNER



[MICHAEL VOIGT]

- 2005 IPSC World Championship 1st Gold Team Member
- 2005 IPSC Australasian Championship 1st Standard Handgun and Open Shotgun
- 2005 DPMS 3 Gun Champion
- 3-TIME SPORTSMAN TEAM CHALLENGE CHAMPION
- 4-TIME NORTH AMERICAN 3 GUN CHAMPION
- 8-TIME USPSA 3 GUN NATIONAL CHAMPION
- 2000-2007 USPSA President



[TOM CABELL]

- 2001 USPSA Limited 10 National Champion
- 1989-1977 Member of USPSA Shooting Team
- 1986 USPSA Team Captain



[DOUG KOENIG]

- 2005 Masters International Champion (12th time)
- 2005 NRA Bianchi Cup Champion (9th time)
- 2001 Steel Challenge Champion (3rd time)
- 1990 IPSC World Champion
- 2005 Sportsman's-Team Challenge Champion (9th time)
- 2004 World Action Pistol Champion (2nd time)



1060
[SHOULDER HOLSTER SYSTEM]

- Unique harness system is comfortable and fully adjustable
- Available with either magazine holder or speedloader pouch
- Optional Model 1061 Handcuff Pouch available
- Fits pistols and revolvers
- Available in Plain Black finish

1061 NOT SHOWN
[HANDCUFF POUCH]

- Optional handcuff pouch for the Model 1060 Shoulder Holster System
- Available in Black

1060
1060 MAG POUCH
[HARNESSES]

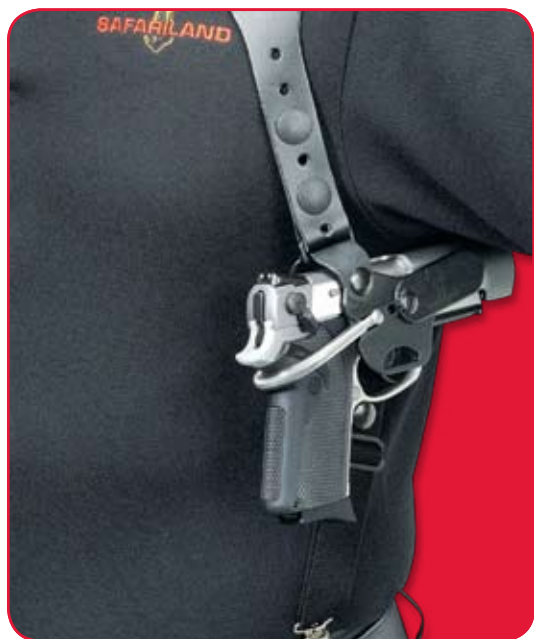

1090 GUN QUICK™

1090
[GUN QUICK™ SHOULDER HOLSTER]

- Engineered for medium- and large-frame pistols
- Fits more than 90 pistol designs
- Ambidextrous shoulder holster
- Easy-to-adjust barrel length and width
- Retention spring allows for easy one-hand re-holstering
- For pistols only
- Available in Plain Black finish



TS-6400
[AQUA DRY POLO SHIRT]

- Continental placket with two horn buttons, hemmed sleeves and bottom
- Available in Black with red trim with SAFARILAND® logo embroidered on left chest
- Sizes: M, L, XL, and XXL

TS-9250
[SAFARILAND HAT]

- Adjustable size fits all
- Low-profile, Black with embroidered logo on front and SAFARILAND® on back and on edge of bill

TS-2400
[MOCK TURTLENECK]

- Team SAFARILAND® Competition long-sleeve T-shirt
- Make of 100% cotton fabric—Hanes® with spandex-enhanced cuffs and neck
- Silk-screened front, back on the sleeves with SAFARILAND® logo
- Available in Black
- Sizes: M, L, XL, and XXL

DECAL-NP-6
[NYLOK WINDOW DECAL]

- NYLOK® PRO 6" (15cm) window decal



TV
[TRAINING VIDEOS]

- New Systems Approach Video covers Duty Holsters/Belt Systems/NYLOK® PRO
- Wide selection of informative training videos available
- Available in VHS, CD-ROM, DVD & PAL



P-201
[PATCH]



HK-10-12
HK-10-144
[HANDCUFF KEY DISPLAY]

- Available with 1 dozen keys, or twelve dozen keys (twelve displays)



SAF-CUP-1
[STAINLESS STEEL TRAVEL MUG]

- 14 oz stainless steel tumbler with plastic liner and top
- Laser engraved with SAFARILAND® logo



075-2
[HEARING PROTECTION PROTECTOR HOLDER]

- Available in Plain Black finish

[NOT SHOWN]

- SAF-PIN** SAFARILAND® Lapel Pin
- 070-CA** Model 070 SSIII holster cut-away
- 295-CA** Model 295 holster cut-away
- LAM-CA** Laminate cut-away
- 6070-CA** Model 6070 holster cut-away
- 6360-CA** Model 6360 holster cut-away



HARDWARE KIT

- Kit provides the necessary materials: screws, rollers, washers, t-nuts, hook and Allen wrench to service a SAFARILAND® Holsters.

BLUE GUN

- Approximately the same weight as a loaded handgun
- Excellent tool for weapon retention & handgun training
- International blue color for non-lethal weapons
- Will not bend out of shape or break, can take the abuse
- Can mount lights to blue guns
- Correct dimensions for SAFARILAND® holsters

SAFARILAND® SLAT WALL DISPLAY**POP-METALSHF-01**

- SAFARILAND® Metal Shelf for Slat Wall

POP-METALSHF-03

- Table Top Shelf

POP-SIGNHLDR-01

- Sign Holder 8.5" x 11" (22 x 28cm) for Slat Wall

POP-SIGNHLDR-02

- Sign Holder 3" x 5" (8 x 13cm) for Slat Wall

POP-SIGNHLDR-05

- Sign Holder for Flyers, 8.5" x 11" (22 x 28cm) for Slat Wall

POP-SLATWALL-01

- Black shelf for three-ring binder for Slat Wall

POP-SLTHOOK-01

- NYLOK® PRO Slat Wall Hooks 12" Long

POP-DSPLYCD

- Product Display Cards 3" x 5" (8 x 13cm) for Slat Wall or Peg Board

SAFARILAND® PEG BOARD DISPLAY**POP-3RNGBNRD-01**

- Three-ring binder with literature

POP-METALSHF-02

- SAFARILAND® Metal Shelf for Peg Board

POP-PEGWALL-01

- Black shelf for three-ring binder 23.5" x 14" x 3" (58 x 16 x 8cm) for Peg Board

POP-SIGNHLDR-03

- Sign Holder 8.5" x 11" (22 x 28cm) for Peg Board

POP-SIGNHLDR-04

- Sign Holder 3" x 5" (8 x 13cm) for Peg Board

POP-DSPLYCD

- Product Display Cards 3" x 5" (8 x 13cm) for Slat Wall or Peg Board

SAFARILAND® REORDER TAGS**SAF-ROC-12/02**

- Reorder tags Duty Gear Products

NP-ROC-12/02

- Reorder tags NYLOK® PRO Products

POP-BACKLGT-01

- SAFARILAND® Backlight Sign

SAFARILAND® BELT DISPLAY RACK**POP-BELTRACK-01**

- Belt Grid Rack 24" X 60" (61 x 152cm)

POP-BELTSIGN-01

- Belt Rack Sign SAFARILAND®

POP-BLTHOOKS-01

- Belt Rack Hooks 12" Long

POP-NYLOKSIGN-01

- Belt Rack Sign NYLOK® PRO

DECAL-6

- SAFARILAND® decal, 6" (15cm)

BAN-100-3, BAN-100-9

- SAFARILAND® banners 6' and 9'

POP-NPL-CD (not shown)

- NYLOK® PRO Product images CD

**SAFARILAND® Slat Wall Display****POP-METALSHF-03****SAFARILAND® Packaging Sample & Reorder Tags****SAFARILAND® Peg Board Display****SAFARILAND® Backlight Sign****Belt Display Rack****BAN-100-9****BAN-100-3****POP-NYLOK SIGN-01****DECAL-6****CONSUMER WARNING: READ IMMEDIATELY**

SAFARILAND® Holsters and Duty Gear systems are designed to meet the demand for high performance police products. Close tolerances for holster/handgun fit require consistent handgun specifications and characteristics as well as extremely precise holster design.

For more than 40 years, SAFARILAND has produced products of quality materials with efficiency and safety in mind. For your protection and safety, it is strongly suggested that these warnings be read, understood, and adhered to prior to the purchase or use of any SAFARILAND product.

Although these warnings may not pertain to all SAFARILAND products, or all circumstances, they should be read prior to the purchase, sale or use of any SAFARILAND product.

Some SAFARILAND products have special and/or supplemental instructions and/or safety information that must be read prior to their use. Call SAFARILAND® (800) 347-1200 for copies of these materials.

[TRAINING AND PRACTICE]

Use of a handgun under any circumstance may be dangerous. SERIOUS INJURY OR EVEN DEATH may result without proper training in the safe handling of firearms. Proper training should be obtained from an accredited firearms safety program conducted by competent, qualified instructors in the military, police academies or National Rifle Association affiliated instruction programs.

We strongly recommend a regular holster practice regime be utilized to assure the continued capabilities of both the SAFARILAND product and its user. Should you have any questions concerning your SAFARILAND products, call SAFARILAND toll free at (800) 347-1200.

[PROPER HOLSTER FIT]

NEVER PLACE A LOADED HANDGUN IN A HOLSTER WITHOUT FIRST TESTING FOR PROPER FIT WITH THE HANDGUN UNLOADED. Although SAFARILAND attempts to provide accurate information regarding which specific holster models were designed to accommodate a specifically identified handgun, or handguns, SAFARILAND does not warrant the accuracy of such information and specifically disclaims any responsibility or liability for, or consequences resulting from errors or inaccuracies in such information. Users are advised not to rely on such compatibility information but are advised to personally verify holster/handgun compatibility in each and every case using actual products.

Handgun manufacturers continually update manufacturing specification in their quest for better products. These changes may occur one or more times within a particular handgun model year, and make it difficult for proper handgun identification and holster fit.

The slightest change in handgun design can have a major safety effect on the SAFARILAND close tolerance products. These changes may not affect other holster brands that do not maintain the SAFARILAND high standards.

If the user has any questions or doubt concerning holster fit, contact SAFARILAND immediately as to which version of a particular handgun you and/or your customer may possess and its compatibility with SAFARILAND holsters.

Be advised that it is the user's responsibility to periodically check his or her holster and related hardware for proper fit and function. Should any product, including a SAFARILAND product, become worn, loose, broken, defective or ill fitting, CEASE USE IMMEDIATELY.

[OTHER VERY IMPORTANT WARNINGS]

DO NOT use SAFARILAND holsters with custom or modified guns, broken, worn or inferior manufactured guns, including guns that are not of original factory specifications. DO NOT use after-market grips not manufactured by SAFARILAND, grip adapters, target hammers, target triggers, or trigger shoes. After market handgun modifications may cause improper holster fit and ACCIDENTAL HANDGUN DISCHARGE. Never attempt to modify SAFARILAND products in any way.

Do not attempt to cock a handgun while holstered as such cocking can cause severe damage to either the handgun or holster, or both, and may cause an ACCIDENTAL DISCHARGE.

Some users of certain handgun models insist on carrying the weapon in what is referred to as a cocked and locked condition (i.e., the gun is cocked with the safety engaged). SAFARILAND does not recommend or approve of any such practice, and advises against it. This condition for such handguns should be reserved only for the most advanced, experienced and skilled professional shooters under conditions that require the handgun to be drawn and fired under extremely short time constraints. Carrying a handgun in this condition INCREASES THE RISK OF ACCIDENTAL DISCHARGE. It should only be used by those who have the training and experience to recognize the inherent risks associated with it.

It should be noted that NO HOLSTER IS COMPLETELY SNATCH-PROOF OR TAKEAWAY-PROOF. Therefore, the user must exercise extreme diligence at all times in any situation where another person may attempt to take the user's handgun. The handgun should be held in place by the user whenever vigorous activity such as running, jumping, falling or tumbling is encountered or attempted. ALWAYS keep safety straps snapped if the holster is so equipped.

Keep thumb on back of hammer or slide when inserting handgun in holster to help assure no movement occurs during insertion. Always keep fingers clear of trigger when drawing or replacing handgun in holster. Place index finger on outside of trigger guard to resist inadvertent strap or foreign object interference when re-holstering.

For complete ordering instructions and additional information please visit www.safariland.com.



SAFARILAND

[3120 E. MISSION BLVD. • ONTARIO, CALIFORNIA USA 91761]

(909) 923-7300 • FAX (909) 923-7400

(800) 347-1200 (USA ONLY)

www.safariland.com • www.holsters.com

